

TOSVERT VF-AS1/PS1

Trace Tool PCT001Z-E

Instruction Manual

Notes

1. Be sure to read this manual carefully before connecting and using the trace tool for the VF-AS1/PS1.
After reading the manual, be sure to store it.
2. The contents of this manual are subject to change without prior notice.

— Contents —

1. Introduction	1
2. How to use PCT001Z-E	3
2.1. ENABLING MACROS	3
2.2. LICENSE AGREEMENT	3
2.3. OPENING WINDOW	4
2.4. SETTING SHEET	5
2.5. GRAPHIC SHEET.....	10
2.6. DATA SHEET.....	12
3. Troubleshooting	14

1.Introduction

The trace tool “PCT001Z-E” for VF-AS1/PS1 is software that performs the following functions when used with an inverter connected to a computer via an RS-485 communications device. Read this manual carefully along with the instruction manual for VF-AS1/PS1 before using PCT001Z-E and use it correctly.

- Exporting and Importing trace function-related parameters
- Reading information on the inverter
- Reading trace data
- Displaying read trace data in graphic form
- Storing trace data

*1 PCT001Z-E does not support any inverters other than VF-AS1/PS1.

*2 To use PCT001Z-E, the USB converters unit shown in Fig. 1 below are required.

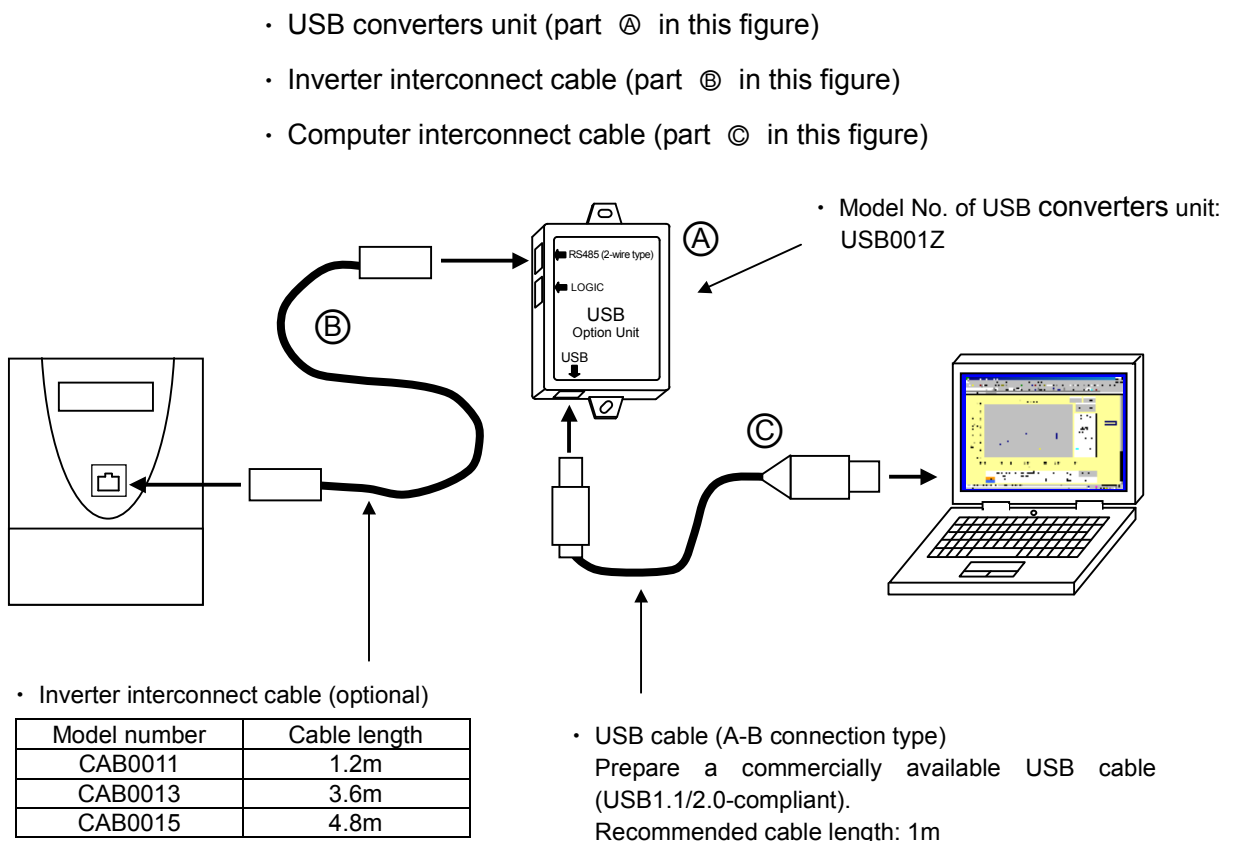

Fig.1 An example of connection of USB converters unit

*3 System requirements

Personal computer with Microsoft® Excel® installed

Others: A serial port or a USB port is required for the computer to connect to the inverter.

It is recommendable to use a mouse or a similar pointing device for operation.

*4 PCT001Z-E may not run normally on some types of PC-98 series computers.

*5 It has been confirmed that PCT001Z-E runs normally on the software listed in the table below.

Microsoft Excel	MS-Excel 2000	MS-Excel 2003
English version	○	○

*6 When using an optional USB communication converter, connect the converter before starting PCT001Z-E. Do not plug or unplug the connector when PCT001Z-E is running.

*7 How to install PCT001Z-E

To install PCT001Z-E, just extract the zip file and move it into the desired folder.

Take the following precautions when installing PCT001Z-E.

- Exit running application programs.
- When updating latest PCT001Z-E, uninstall the old version of PCT001Z-E. (The version of PCT001Z-E is shown in the Opening window (section 2.3).)

*8 How to uninstall PCT001Z-E

To uninstall PCT001Z-E, just remove the folder containing PCT001Z-E from the computer.

☆ The specifications of this software is subject to change without notice.

☆ Toshiba Schneider Inverter assumes no responsibility for damage caused directly or indirectly by the use or a malfunction of this software product.

☆ These system requirements are minimum conditions required for the use of PCT001Z-E. They do not guarantee that all functions of PCT001Z-E are performed normally.

☆ Windows® is listed as the abbreviation for a Microsoft® Windows® operating system. Microsoft® Windows® and Microsoft® Excel® are registered trademarks or trademarks of the US Microsoft Corporation in the USA and other countries.

☆ PC-98 series is a trademark or registered trademark of NEC Corporation.

☆ The symbols used in this manual have the following meanings.

[]: Buttons or radio buttons in windows of PCT001Z-E or Microsoft Windows

' ': Menu items of PCT001Z-E

2.How to use PCT001Z-E

This section explains how to use PCT001Z-E.

2.1.Enabling macros

When PCT001-E is started for the first time, the dialog box shown in Fig. 2 may appear. If it appears, click the [Enable Macros] button, because PCT001Z-E uses macros.

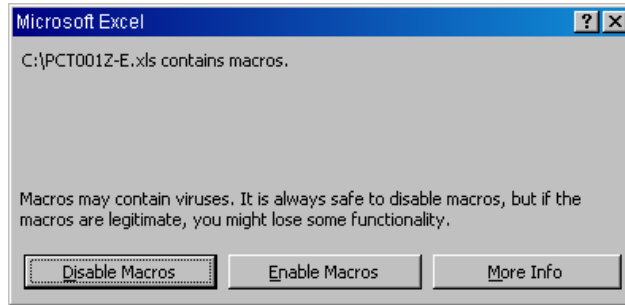

Fig. 2 Security warning

2.2.License agreement

When PCT001Z-E is started for the first time or after macros have been enabled, the PCT001Z-E license agreement window (Fig. 3) appears. Read the contents carefully and click [agree] if you wish to use PCT001Z-E. Clicking [don't agree] closes the Excel book.

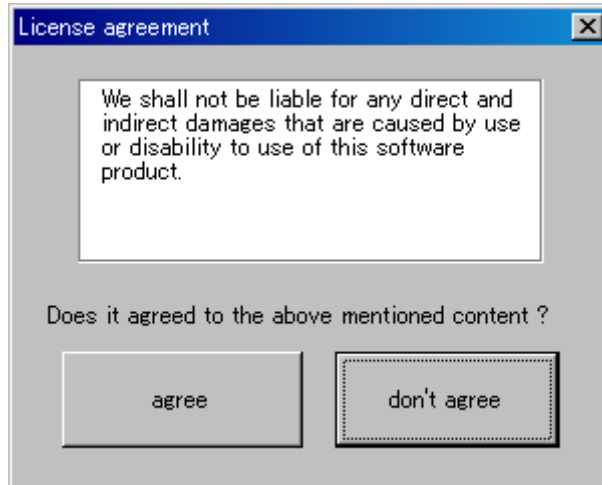

Fig.3 License agreement

2.3. Opening window

When macros are executed, the Opening sheet (Fig. 4) appears. After reading the instruction manual (this manual) carefully, click [To setting >] in the top-right of the window and make necessary settings.

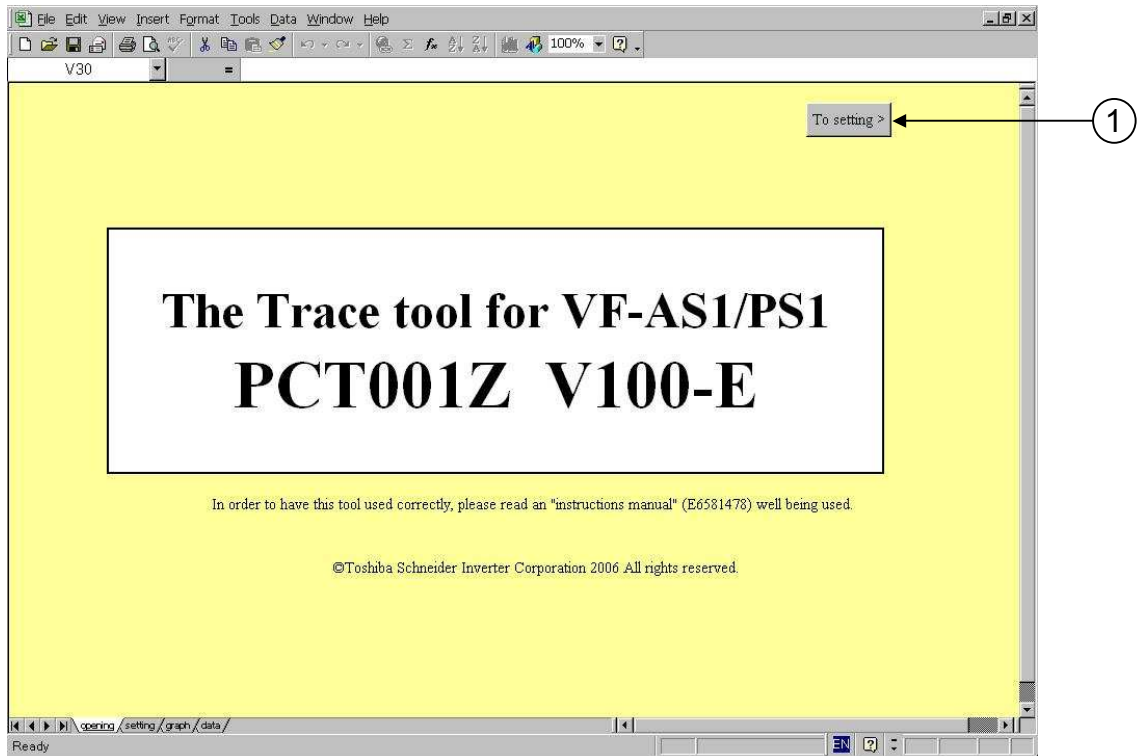

Fig. 4 Opening window

① [To setting >]

Click this button to move from the Opening sheet to the Setting sheet.

2.4. Setting sheet

The Setting sheet (Fig. 5) allows you to make settings necessary for communications between the inverter and the computer and to export and import related parameters.

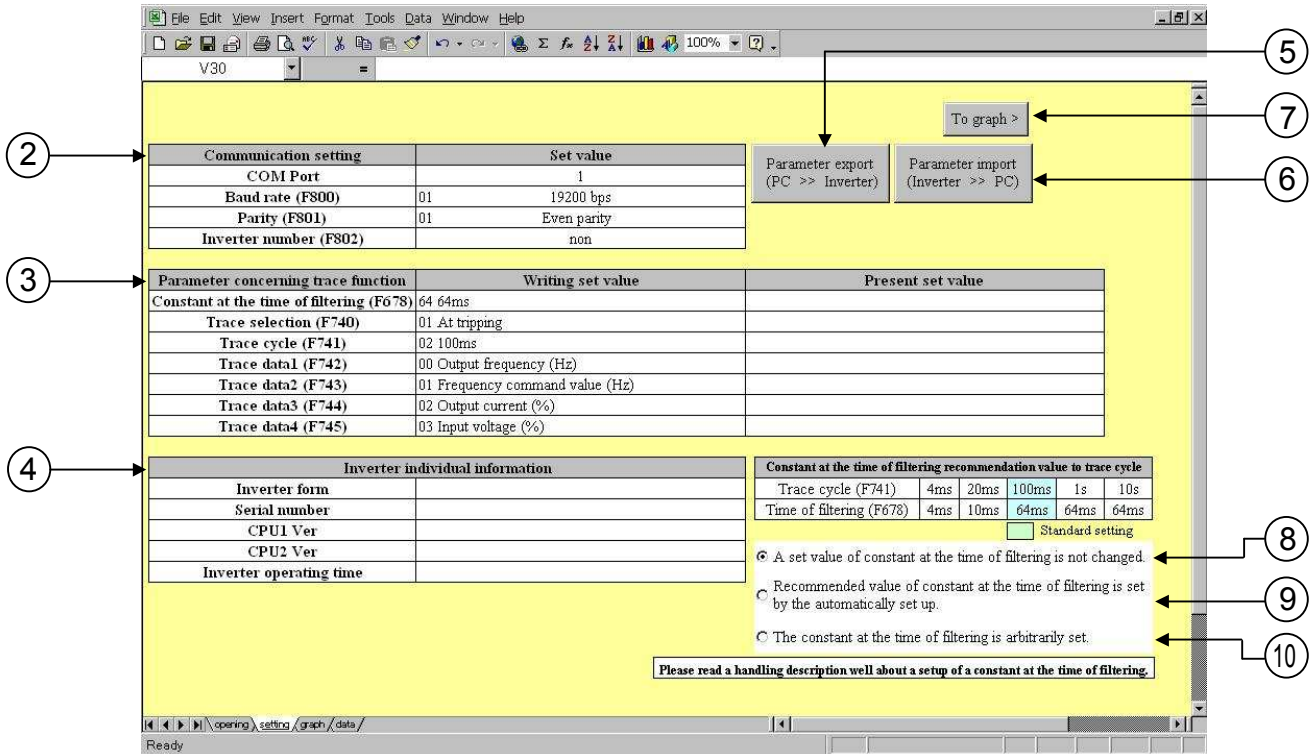

Fig. 5 Setting sheet

② Communication setting^{*1}

Communication setting	Set value
COM Port	1
Baud rate (F800)	01 19200 bps
Parity (F801)	00 9600 bps
inverter number (F802)	01 19200 bps
	02 38400 bps

Fig. 6 Communication setting

'COM Port': Specify the COM port number of the computer.

'Baud rate': Specify the baud rate (F800) of the inverter.

'Parity': Specify the parity (F801) of the inverter.

'Inverter number': Specify the number (F802) assigned to the inverter.

Since PCT001Z-E uses the Toshiba inverter protocol ASCII mode, only a number between 0 and 99 can be assigned to an inverter.

*1 If you select a parameter other than parameters set for the inverter or the computer connected to it, an error may occur during communication.

Table 1 Table of settings for communications with inverter

Title	Content	Adjustment range	Default setting
-	COM port	1~30	-
F800	Baud rate	0:9600bps 1:19200bps 2:38400bps	1
F801	Parity	0:Non parity 1:Even parity 2:Odd parity	1
F802	Inverter number	0~99	0

③ Parameter concerning trace function*2

Parameter concerning trace function	Writing set value
Constant at the time of filtering (F678)	64 64ms
Trace selection (F740)	01 At tripping
Trace cycle (F741)	02 100ms
Trace data1 (F742)	00 4ms 01 20ms
Trace data2 (F743)	02 100ms
Trace data3 (F744)	03 1s 04 10s
Trace data4 (F745)	03 Input voltage (%)

Fig. 7 Parameter concerning trace function

'Constant at the time of filtering': Select the size of constant at the time of filtering (F678). *3

'Trace selection': Select the trace data acquisition timing (F740).

'Trace cycle': Select the trace cycle (F741).

'Trace data1': Select type1 (F742) of data.

'Trace data2': Select type2 (F743) of data.

'Trace data3': Select type3 (F744) of data.

'Trace data4': Select type4 (F745) of data.

*2 Set all trace-related parameters before operating the inverter. If after the inverter did trip or trigger that it is changed, that data cannot be read.

*3 Take special care when using analog output signals (FM and AM terminals) with the inverter.

The constant at the time of filtering (F678) also acts on analog output signals.

Therefore, if there is a probability that these output signals will affect the machine, do not change the value of constant at the time of filtering.

By default, the constant is set at 64ms.

Table2 Parameter concerning trace functions

Title	Content	Adjustment range	Default setting
F678	Constant at the time of filtering	4ms~100ms ^{*4}	64
F740	Trace selection	0:Deselect 1:At tripping 2:At triggering	1
F741	Trace cycle	0:4ms 1:20ms 2:100ms 3:1s 4:10s	2
F742	Trace data1	00:Output frequency (Hz) 01:Frequency command value (Hz) 02:Output current (%) 03:Input voltage (%) 04:Output voltage (%) 05:Compensated frequency (Hz) 06:Speed feedback (real-time value) (Hz) 07:Speed feedback (1-second filter) (Hz) 08:Torque (%) 09:Torque command (%) 11:Torque current (%) 12:Exciting current (%) 13:PID feedback value (Hz) 14:Motor overload factor (OL2 data) (%) 15:Inverter overload factor (OL1 data) (%) 16:Regenerative braking resistance overload factor (OLr data) (%) 17:Regenerative braking resistor load factor (%ED) (%) 18:Input power (kW) 19:Output power (kW) 23:Option AI2 input (%) 24:RR/S4 input (%) 25:VI/II input (%) 26:RX input (%) 27:Option AI1 input (%) 28:FM output (%) 29:AM output (%) 34:Integral input power (kWhr) 35:Integral output power (kWhr) 46:My Function Monitor1 ^{*5} 47:My Function Monitor2 ^{*5} 48:My Function Monitor3 ^{*5} 49:My Function Monitor4 ^{*5}	0
F743	Trace data2	Same as trace data1	1
F744	Trace data3	Same as trace data1	2
F745	Trace data4	Same as trace data1	3

*4 5, 6, and 7ms are set as 4ms.

*5 My Function monitors 1 through 4 at 46 through 49 cannot be specified with any parameter between F742 and F745 (kinds of data to be acquired).

④ Inverter individual information

Inverter individual information	
Inverter form	VFAS1-2022PL
Serial number	1234567878909876
CPU1 Ver	130
CPU2 Ver	1.17
Inverter operating time	2 hours

Fig. 8 Inverter individual information

'Inverter form': Displays the type of the inverter.

'Serial number': Displays the serial number of the inverter.

'CPU1 Ver': Displays the version of the inverter's CPU1.

'CPU2 Ver': Displays the version of the inverter's CPU2.

'Inverter operating time': Displays the operating time of the inverter.

⑤ [Parameter export]

Click this button to export the values set for the trace-related parameters (Fig. 7) into the inverter.

⑥ [Parameter import]

Click this button to import the values set for the trace-related parameters (Fig. 7) and information on the inverter (Fig. 8).

⑦ [To graph >]

Click this button to move from the Setting sheet to the Graphic sheet.

⑧ [A set value of constant at the time of filtering is not changed.]

If this radio button is checked, clicking [Parameter export] will not change the value of constant at the time of filtering. (Select this option under normal conditions.)

⑨ [Recommended value of constant at the time of filtering is set by the automatic set up.]^{*5}

If this radio button is checked, clicking [Parameter export] will export the value of constant at the time of filtering recommended for the trace cycle into the inverter. The value set with F678 (constant at the time of filtering), however, does not take effect.

The table below shows correspondences between trace cycle and recommended value of constant at the time of filtering.

Table 3 Correspondence between trace cycle and recommended value of constant at the time of filtering

Trace cycle	4ms	20ms	100ms	1s	10s
Constant at the time of filtering	4ms	10ms	64ms	64ms	64ms

⑩ [The constant at the time of filtering is arbitrarily set.]*⁶

If this radio button is checked, clicking [Parameter export] will export the value of constant at the time of filtering you have selected from the drop-down menu into the inverter.

*6 If you select [Recommended value of constant at the time of filtering is set by the automatic set up.] and [The constant at the time of filtering is arbitrarily set.] to export the set values, the message “Export completion. Please return the base value of Constant at the time of filtering (F678) after data acquisition ends” (Fig. 9) will soon appear.

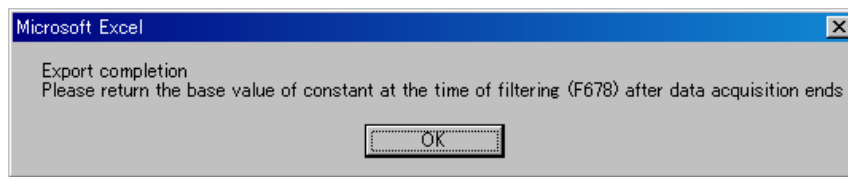

Fig. 9 Confirmation of setting

2.5. Graphic sheet

The Graphic sheet (Fig. 10) allows you to read trace data and display it in graphic form.

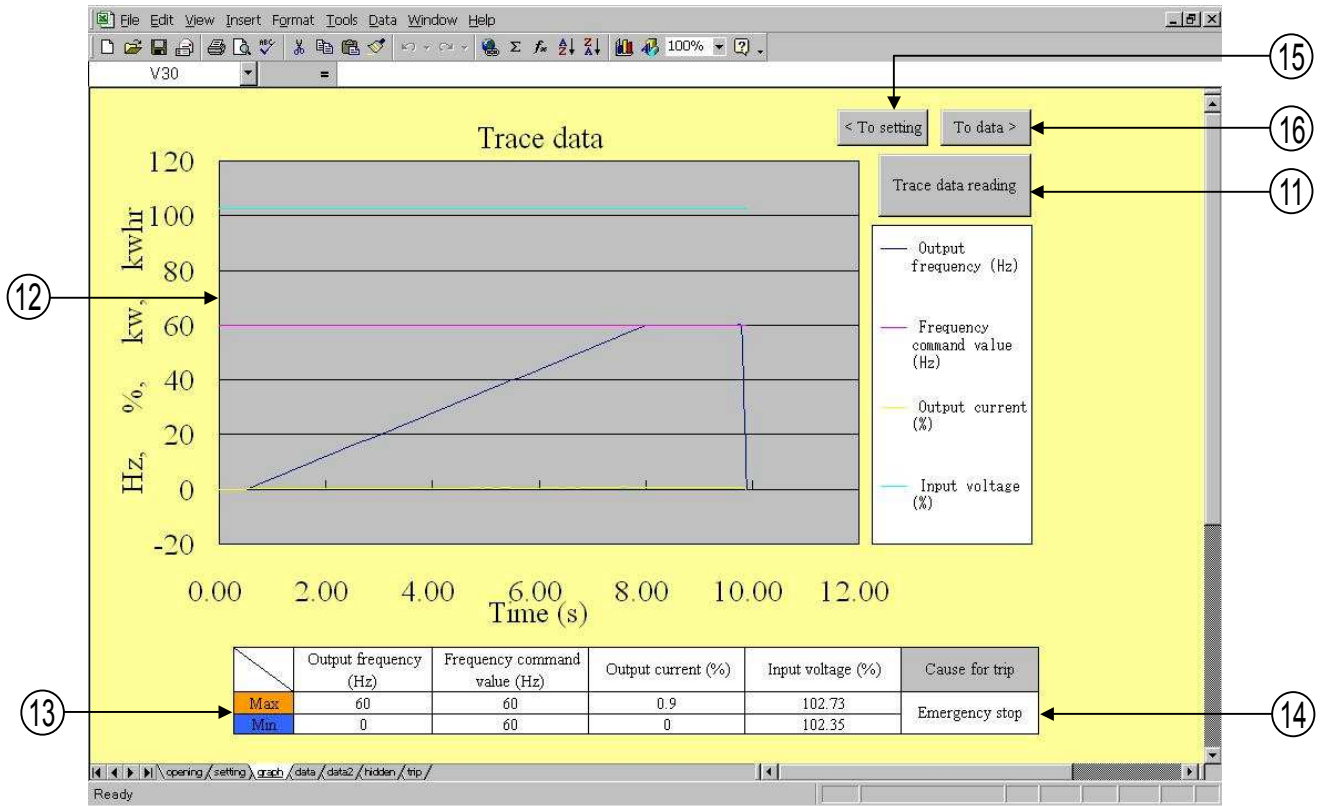

Fig. 10 Graphic sheet

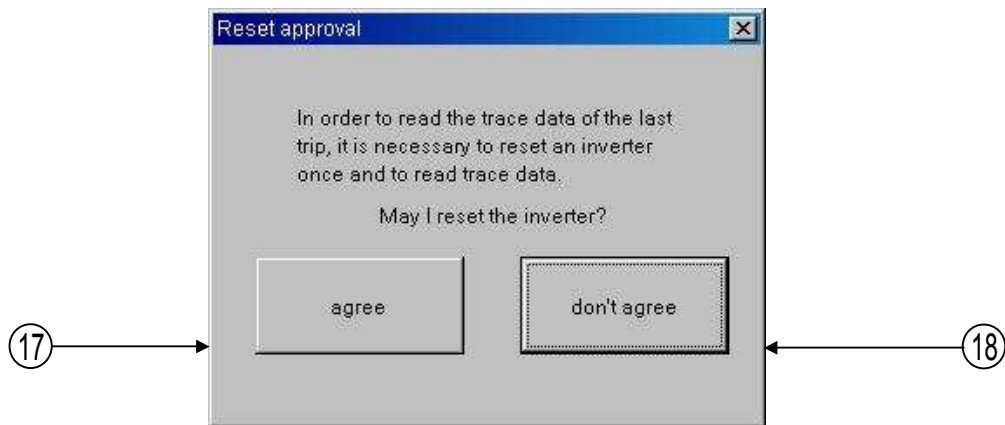

Fig. 11 Reset approval

⑪ [Trace data reading]

Click this button to read trace data stored in the inverter and display it in graphic form. If the inverter is tripped or “at the time of trigger” is not selected for trace selection, the “Reset approval” window (Fig. 11) will appear and data will be read after approval is given, because the inverter needs to be reset before data is read in such cases.

At that time, trace selection on the inverter side is disabled temporarily, so if communications are interrupted halfway, trace selection will remain “disabled.” In that case, return the value of trace selection to its original value.

⑫ 'Graph'

Displays acquired data in graphic form.

⑬ 'Max' 'Min'

Displays the maximum and minimum values of 4 kinds of data acquired.

⑭ 'Cause for trip'

Displays the cause of tripping of the inverter.

⑮ [< To setting]

Click this button to move from the Graphic sheet to the Setting sheet.

⑯ [To data >]

Click this button to move from the Graphic sheet to the Data sheet.

⑰ [agree]

Click this button to reset the inverter and read trace data.

⑱ [don't agree]

Click this button to stop operation without resetting the inverter (no trace data is read).

2.6.Data sheet

The data sheet (Fig. 12) lists 4 kinds of acquired numerical data (data 1 through 4) in groups of 100 each.

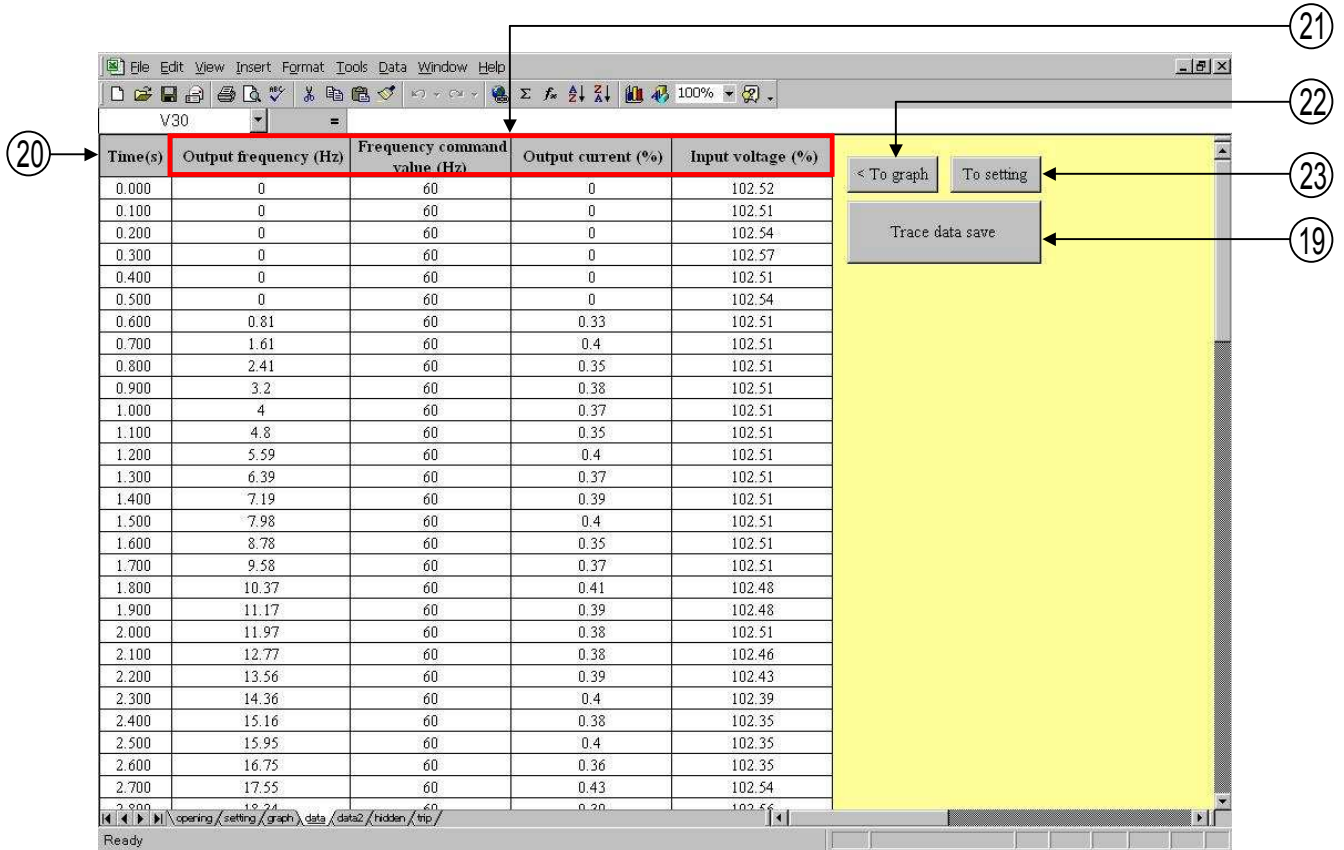

Fig. 12 Data sheet

⑱ [Trace data save]

Click this button to name and save the file automatically. The file name consists of date and time when data is saved. The file name can be changed when saving the file.

An example of a file name assigned automatically is shown in the table below.

- Example of file name

Current date and time	8:30 A.M. on April 1, 2006
Name assigned to the file	TRACE-040120060830.xls

⑳ 'Time(s)'

Displays the time at the same intervals as the trace cycle.

㉑ "4 kinds of data acquired"

Displays 4 kinds of data acquired in groups of 100 each.

㉒ [< To graph]

Click this button to move from the Data sheet to the Graphic sheet.

㉓ [To setting]

Click this button to move from the Data sheet to the Setting sheet.

3. Troubleshooting

This section explains problems that may occur when PCT001Z-E is used.

Q1 : Although the [Trace data reading] button is clicked, time-out occurs.

A1 : Communication between the inverter and the computer is not established. Check whether the cable is connected properly and all settings for communications are made correctly.

Q2 : Although trace data is acquired, no data is displayed or other data is displayed.

A2 : Check whether "Deselect" is selected for 'Trace selection'.

Q3 : Trace data acquired is discontinuous.

A3 : This phenomenon occurs if the inverter is tripped or triggered and the recording of trace data is interrupted before 100 pieces of trace data are collected, and therefore the previous data remains. This phenomenon may occur if the inverter is tripped or triggered immediately after Power supply turning on.

Q4 : The trace tool software has started, but it does not respond to the click of any button.

A4 : This phenomenon occurs if the Excel's macro security is set at 'High' level. To solve this problem, set the macro security at 'Medium' or lower level.

Q5 : The instruction manuals for VF-AS1 and VF-PS1 states that any number of up to 248 can be assigned to an inverter (F802), but only a number of up to 99 can be assigned with PCT001Z-E.

A5 : Since PCT001Z uses the Toshiba inverter protocol ASCII mode, only a number between 0 and 99 can be assigned to an inverter.